

Domestic sliding door gear 30 – 75 kgs

Sliding doors to 30 - 45 kgs

Easy Ern 805

More doors for one track.
For sliding doors to 30 kgs, maximum door thickness 16 mm Each kit will hang two doors.
Use track K-075/aluminium.

Single Sam 365 for one door

For sliding doors to 45 kgs, maximum thickness 40 mm
Use track K-030/aluminium.

Double Don 465 for two doors

For sliding door to 45 kgs, maximum thickness 40 mm
Use track K-040/aluminium



Single Sam

Double Don

Sliding doors to 75 kgs

Basic Bob for metal and wood doors

Set includes fittings and assembly instructions for one door. Use track K-075 steel or aluminium.

Basic Bob 765

Top fixing from the track. No brackets

Basic Bob 755

Set includes wall brackets for face-fixing

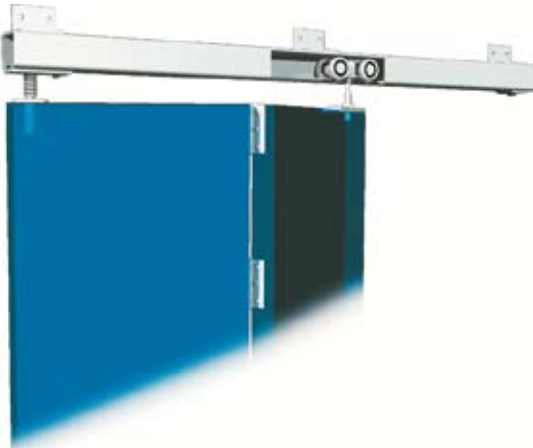

Folding doors

Flexy Fox sets for light folding doors

Maximum weight for door leaf 25 kgs, maximum width 600 mm, maximum height 2400 mm.
Use track K-075 steel or aluminium.

Flexy Fox 902

For two-leaves door

Flexy Fox 904

For two or more leaves door



1 x Single Sam 365
1 x Double Don 465
+ track



1 x Double Don 465
+ track



helaform

P.O.Box 2, Sienikuja 6, 00761 Helsinki, Finland
Tel. +358-9-388 3033, fax +358-9-388 3038
www.helaform.com

Sliding door gear 100 - 1200 kgs

helaform

Serie/Track	Max door weight	Max door size	Distance between brackets
K-100	100 kg	ca. 6 m ²	Use brackets, 1 m interval
K-150	150 kg	ca. 12 m ²	
K-300	300 kg	ca. 25 m ²	
K-500	500 kg	ca. 30 m ²	
K-500	600-1200 kg	over 30 m ²	Brackets in 0,5 m interval

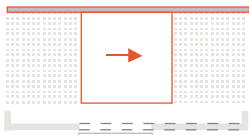
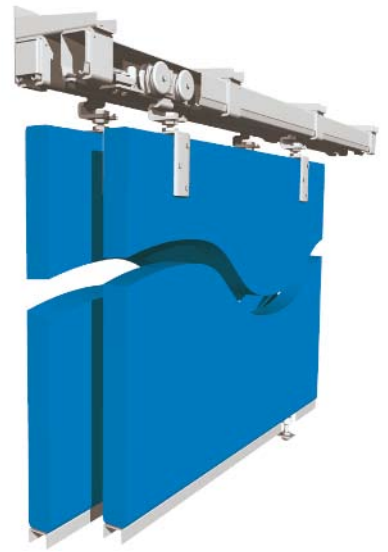
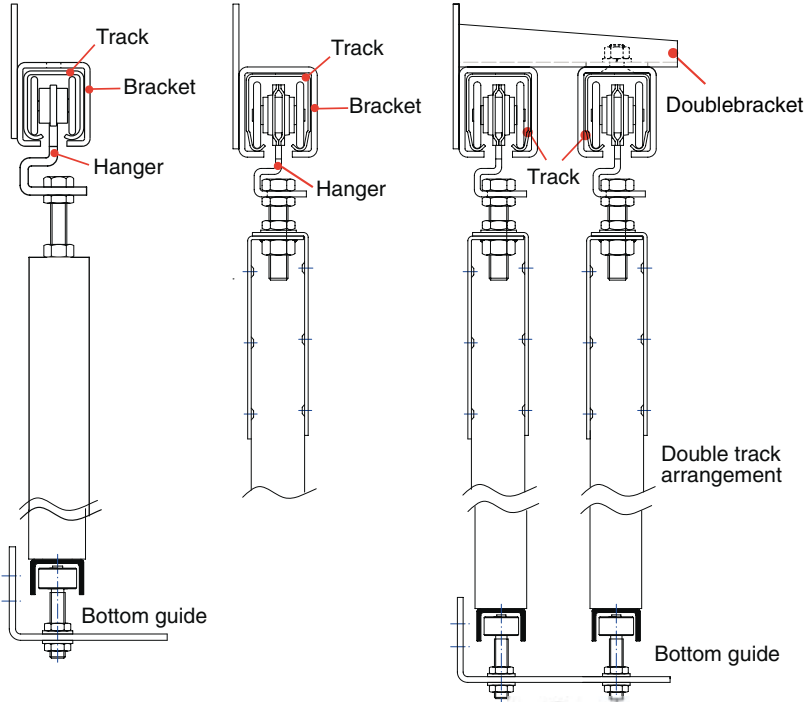

Door size ca. 4 x 4 m
Track 9 m
Bracket 8 pcs
Joint 2 pcs
End clips 2 pcs
Hanger 2 pcs
Stop 2 pcs
Bottom guide track 4,2 m
Bottom guide 1 pc

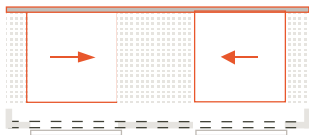

Door size ca. 4 x 4 m
Track 15 m
Bracket 12 pcs
Joint 4 pcs
End clips 2 pcs
Hanger 2 pcs
Stop 2 pcs
Bottom guide track 4,2 m
Bottom guide 2 pcs

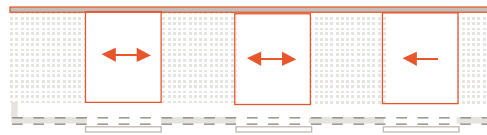

Door size ca. 4 x 4 m
Track 24 m
Bracket 18 pcs
Joint 7 pcs
End clips 2 pcs
Hanger 6 pcs
Stop 2 pcs
Bottom guide track 12,6 m
Bottom guide 5 pcs

Double track arrangement

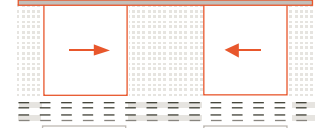

Door size ca. 4 x 4 m
Track 24 m
Double bracket 10 pcs
Joint 3 pcs
End clips 4 pcs
Hanger 4 pcs
Stop 2 pcs
Bottom guide track 8,4 m
Bottom guide 2 pcs