



Forget carrying and lifting heavy weights, use a Helaform light conveyor system to help you

With a simple conveyor system you can easily move your milking machine from stall to stall in your cowshed.

Conveyor system is also suitable for use in paint shops, in theatres for scenery moving, to move heavy tools and many other applications where heavy items need to be moved from one place to another with the minimum effort.

The systems are easy and simple to install, providing a safe and comfortable working environment. No more heavy lifting and possible back strains, making your work load easier and less strenuous.

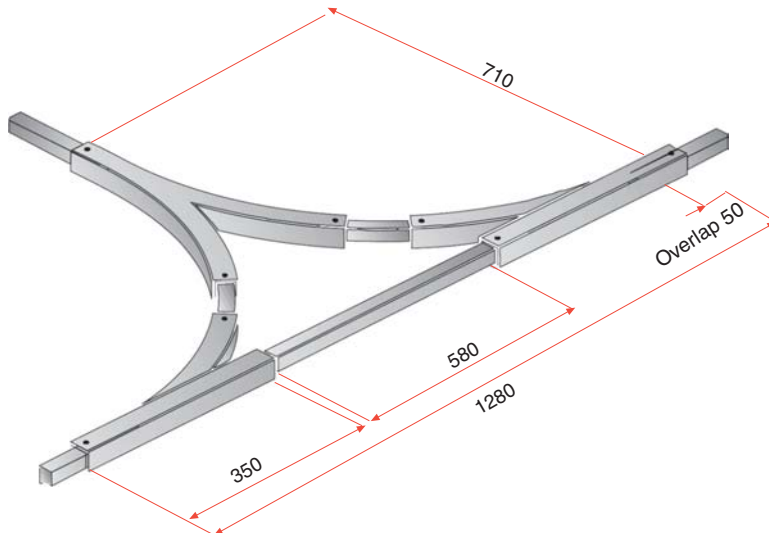

Three-way rail switch, complete
(1x Y-rail switch, 1 x right rail switch,
1 x left rail switch + 2 x curve)

helaform

PL 2, P.O.Box 2, Sienikuja 6,
00761 Helsinki, Finland
Tel. +358-9-388 3033 Fax +358-9-388 3038
www.helaform.com



TRACK K-100 capacity 100 kg, standard length 6 m

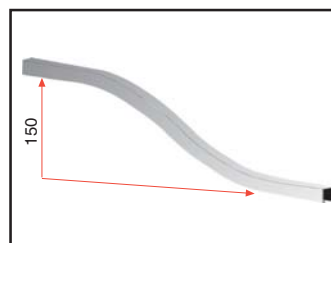
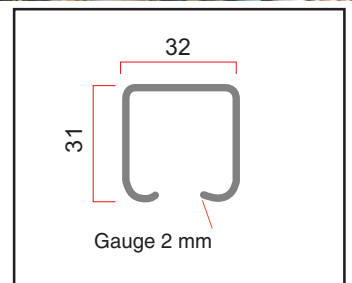

ANDERPASS MODULE
Standard length 80 cm

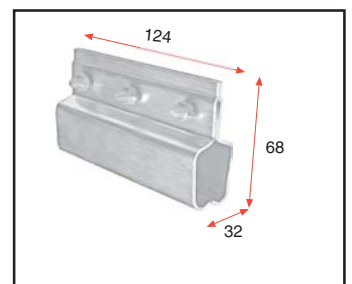

JOINT

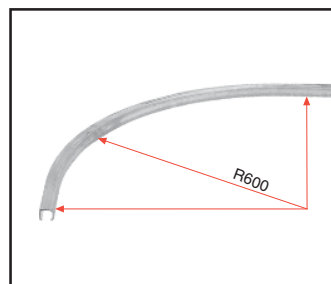

CURVE
90°, radius 600 mm

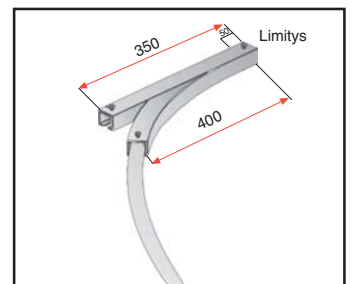

RAIL SWITCH

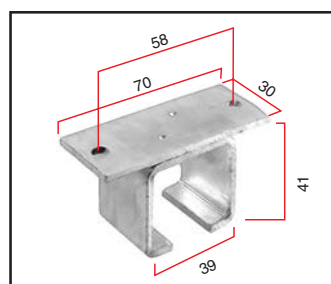

SOFFIT BRACKET KKK-100
Solid

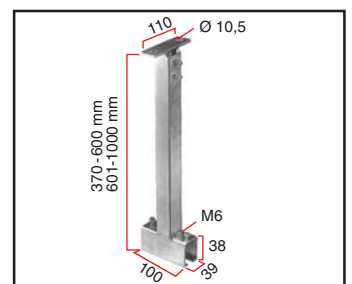

SOFFIT BRACKET KKS-100
370-600mm/601-1000 mm, adjustable